



W4

Supra Heavy-Duty Hose Clamp Stainless Steel

The Supra range is the natural evolution of the Super W1 Clamp. Due to its revolutionary swiveling bridge, Supra W4 can be mounted in the most awkward applications without having to remove the hose. It can be opened up and fastened again when in place without dislodging any other parts of the clamp, making assembly much easier.

Thanks to the beveled edges, the hose is protected from damage. The Supra W4 clamp complies fully with the RoHS directive EU 20032/95/EC dated 1st July 2006.

The stainless steel bolt together with the captive nut and spacer system allow you to clamp the most demanding of hose assemblies. Supra W4 is a full stainless steel clamp, destined for demanding applications where high corrosion resistance is vital. This top of the range heavy-duty clamp is ideal for marine applications and the foodstuffs industry, as well as for countless industrial applications where AISI-304 stainless steel is specified.

* Special dimensions are available on request.

* The maximum application pressure can vary depending on the type of hose used and the geometry of the coupling.

Patented Worldwide.

Supra W4

Application Ø		Part n° W4	r	e	a	b	Max. Values* Torque (Nm)	Max. Values* Pressure (Bars)	Box Quantity (MOQ)	Packing
mm	inches									
17-19	11/16-3/4	03013016	M6	8	18 ⁺⁰²	19,8	10	40	50	400
19-21	3/4-53/64	03013024	M6	8	18 ⁺⁰²	19,8	10	40	50	400
21-23	53/64-29/32	03013032	M6	8	18 ⁺⁰²	19,8	10	40	50	400
23-25	29/32-1	03013040	M6	8	18 ⁺⁰²	19,8	10	40	50	400
25-27	1-1-1/16	03013059	M6	8	18 ⁺⁰²	19,8	10	40	50	400
27-29	1-1/16-15/32	03013067	M6	8	18 ⁺⁰²	19,8	10	40	50	200
29-31	1-5/32-1-7/32	03013075	M7	11	20 ⁺⁰³	22	12	35	50	50
31-34	17/32-1-11/32	03013083	M7	11	20 ⁺⁰³	22	12	35	50	50
34-37	1-11/32-1-29/64	03013091	M7	11	20 ⁺⁰³	22	12	35	50	50
37-40	1-29/64-19/16	03013104	M7	11	20 ⁺⁰³	22	12	35	50	50
40-43	1-9/16-1-11/16	03013112	M7	11	20 ⁺⁰³	22	12	35	50	50
43-47	1-11/16-1-27/32	03013120	M7	11	20 ⁺⁰³	22	12	35	50	50
47-51	1-27/32-2-1/64	03013139	M7	11	20 ⁺⁰³	22	16	30	50	50
51-55	2-1/64-2-11/64	03013147	M7	11	20 ⁺⁰³	22	16	30	25	25
55-59	2-11/64-2-21/64	03013155	M7	11	20 ⁺⁰³	22	16	30	25	25
59-63	2-21/64-2-31/64	03013163	M7	11	20 ⁺⁰³	22	16	30	25	25
63-68	2-31/64-2-11/16	03013171	M7	11	20 ⁺⁰³	22	16	30	25	25
68-73	2-11/16-3-7/8	03013180	M8	13	25 ⁺⁰⁴	27,5	30	20	25	25
73-79	3-7/8-3-7/64	03013198	M8	13	25 ⁺⁰⁴	27,5	30	20	25	25
79-85	3-7/64-3-11/32	03013200	M8	13	25 ⁺⁰⁴	27,5	30	20	25	25
85-91	3-11/32-3-37/64	03013219	M8	13	25 ⁺⁰⁴	27,5	30	15	25	25
91-97	3-37/64-3-13/16	03013227	M8	13	25 ⁺⁰⁴	27,5	30	15	25	25
97-104	3-13/16-4-3/32	03013235	M8	13	25 ⁺⁰⁴	27,5	30	15	25	25
104-112	4-3/32-4-3/8	03013243	M8	13	25 ⁺⁰⁴	27,5	30	10	25	25
112-121	4-3/8-4-49/64	03013251	M8	13	25 ⁺⁰⁴	27,5	30	10	25	25
121-130	4-49/64-5-1/8	03013260	M8	13	25 ⁺⁰⁴	27,5	30	10	25	25
130-140	5-1/8-5-33/64	03013278	M10	15	28 ⁺⁰⁴	31	45	6	10	10
140-150	5-33/64-5-29/32	03013286	M10	15	28 ⁺⁰⁴	31	45	6	10	10
150-162	5-29/32-6-3/8	03013294	M10	15	28 ⁺⁰⁴	31	45	6	10	10
162-174	6-3/8-6-7/8	03013307	M10	15	28 ⁺⁰⁴	31	45	3	10	10
174-187	6-7/8-7-23/64	03013315	M10	15	28 ⁺⁰⁴	31	45	3	10	10
187-200	7-23/64-7-7/8	03013323	M10	15	28 ⁺⁰⁴	31	45	3	10	10

Application Ø		Part n° W4	r	e	a	b	Max. Values* Torque (Nm)	Max. Values* Pressure (Bars)	Box Quantity (MOQ)	Packing
mm	inches									
200-213	7-7/8-8-25/64	03013331	M10	15	28 ⁺⁰⁴	31	45	3	10	10
213-226	8-25/64-8-57/64	03013340	M10	15	28 ⁺⁰⁴	31	45	3	10	10
226-239	8-57/64-9-13/32	03013358	M10	15	28 ⁺⁰⁴	31	45	3	10	10
239-252	9-13/32-9-59/64	03013366	M10	15	28 ⁺⁰⁴	31	45	3	10	10
252-265	9-59/64-10-7/16	03013374	M10	15	28 ⁺⁰⁴	31	45	3	10	10
265-278	10-7/16-10-151/6	03013390	M10	15	28 ⁺⁰⁴	31	45	3	10	10
278-291	10-15/16-11-29/64	03013422	M10	15	28 ⁺⁰⁴	31	45	3	10	10
291-304	11-29/64-11-31/32	03013433	M10	15	28 ⁺⁰⁴	31	45	3	10	10
304-317	11-31/32-12-31/64	03013444	M10	15	28 ⁺⁰⁴	31	45	3	10	10
317-330	12-31/64-12-63/64	03013403	M10	15	28 ⁺⁰⁴	31	45	3	10	10
330-343	12-63/64-13-1/2	03013455	M10	15	28 ⁺⁰⁴	31	45	3	10	10
343-356	13-1/2-14-1/64	03013466	M10	15	28 ⁺⁰⁴	31	45	3	10	10
356-36*9	14-1/64-14-17/32	03013477	M10	15	28 ⁺⁰⁴	31	45	3	10	10
369-382	14-17/32-15-3/64	03013488	M10	15	28 ⁺⁰⁴	31	45	3	10	10
382-395	15-3/64-15-35/64	03013499	M10	15	28 ⁺⁰⁴	31	45	3	10	10
395-408	15-35/64-16-1/16	03013500	M10	15	28 ⁺⁰⁴	31	45	3	10	10

W4 Band and Bridge: X5CrNi 1810 Stainless steel (DIN 1.4301)(AISI-304) (A2) **Bolt:** (AISI-304) Cu Stainless steel

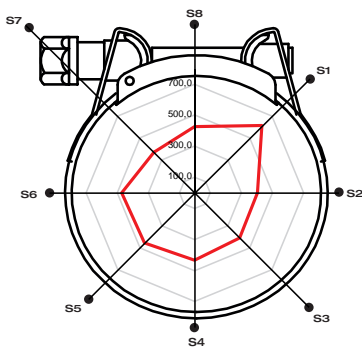

Polar Diagram

● Sectors	S1	S2	S3	S4	S5	S6	S7	S8
— 35 Nm	611,0	404,0	410,0	435,0	456,0	472,0	372,0	428,0

Torque / Efficiency [Nm / daN]

